

MODEL: AGS-800-D

Rail Detail

Plan View Of Grille

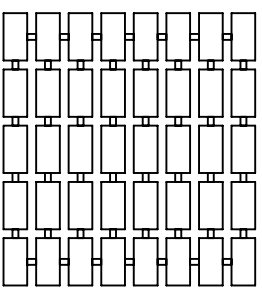
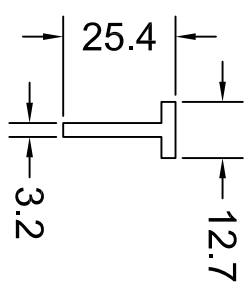

LENGTH OF GRILLE

SECTION Y-Y

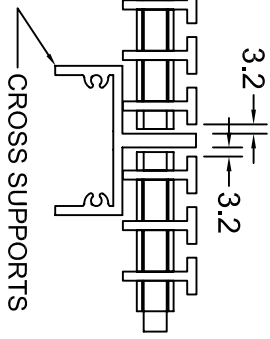
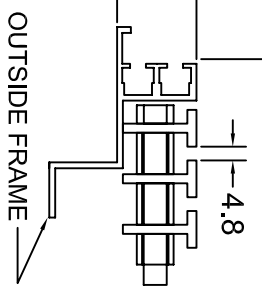

SECTION W-W

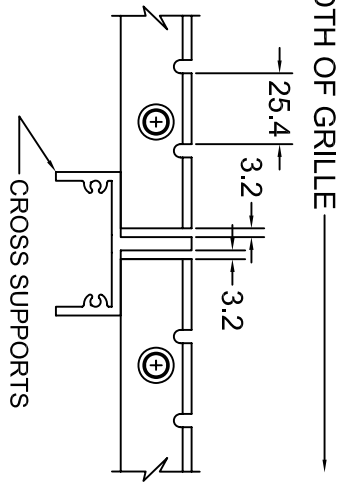
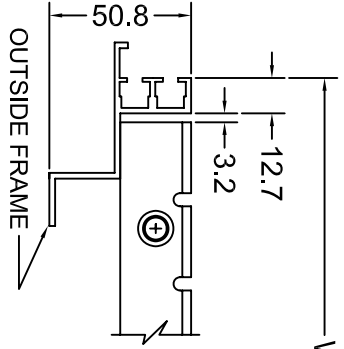

WIDTH OF GRILLE

SECTION X-X

SECTION Z-Z

Project:	Sheet:
Architect:	of
Customer:	Date:
Rep.:	

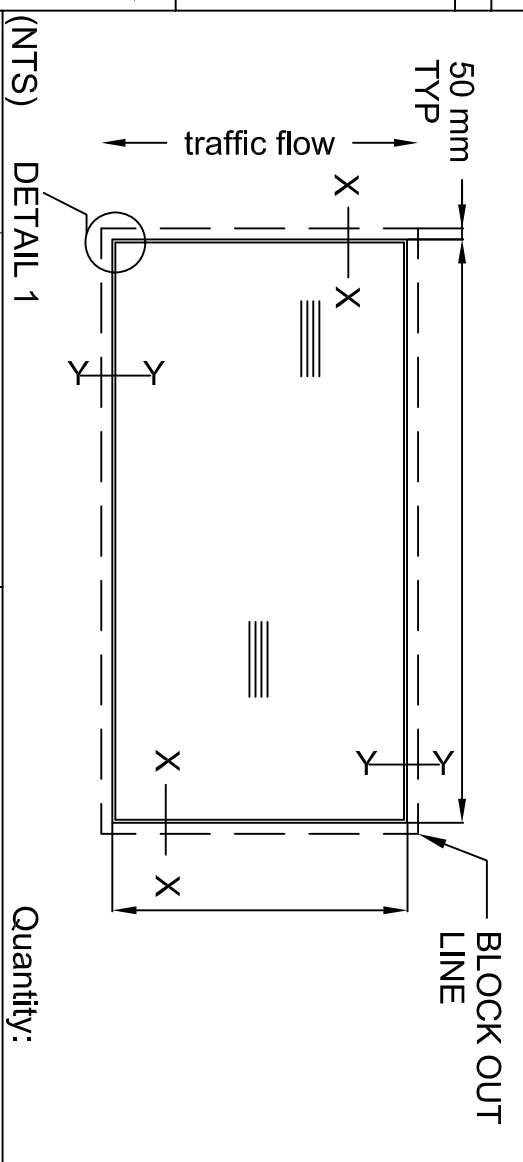

ASSEMBLY CLIP

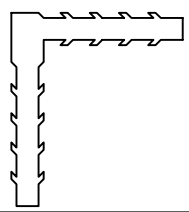

CORNER MITRE ASSEMBLY

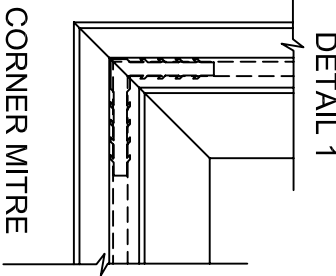

CROSS SUPPORT ASSEMBLY

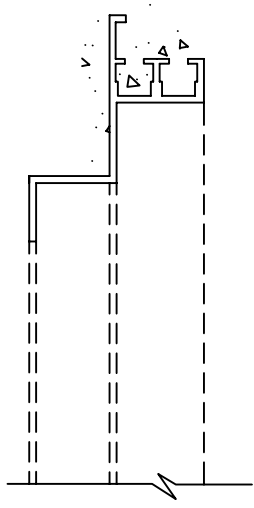

GRILLES

Material : Aluminium 6061-T6
 Assembly : 5/16" Steel rods
 1/2" Aluminium spacers

FRAMES

Type: D
 Material : Aluminium 6061-T6
 Assembly : Field installed with corner clips

Finish Options : Mill
 Clear anodized
 Bronze anodized

Finish Options: Mill
 Clear anodized
 Bronze anodized

Pan Options

- 20G.Gal.steel
- 16G.Aluminum
- 20G.Stainless steel

Assembly

Factory installed to inside of frame pocket

Accessories

- Drain
- Hinge
- Lock down

File #	No.	By:	Date:	Approved:
P.O.	Revision Record:			
1734 Orangebrook Court Pickering, Ont. L1W 3G8, Canada Tel: 905-420-0485 / 1-888-624-4557 Fax: 905-420-4564 / 1-888-624-4558 engineering @ the-mcgill-group.com http://www.the-mcgill-group.com				